



# CleanView® BAGLESS Power Trak®

## USER'S GUIDE

### 3593/3594/6590 SERIES

3 Safety Instructions

4 Product View

5-6 Assembly Instructions

6-9 Operation / Special Tools

10-13 Maintenance

13 Consumer Services

14 Troubleshooting

15 Replacement Parts

16 Warranty

## Thanks For Buying A BISSELL CleanView®

We're glad you purchased a BISSELL CleanView Vacuum. Everything we know about floor care went into the design and construction of this complete, high-tech home vacuuming system.

Your BISSELL CleanView is well made, and we back it with a limited comprehensive one-year warranty. We also stand behind it with a knowledgeable, dedicated Consumer Services Department, so, should you ever have a problem, you'll receive fast, considerate assistance.

My great-grandfather invented the floor sweeper in 1876. Today, BISSELL is a global leader in the design, manufacture, and service of high quality homecare products like your BISSELL CleanView.

Thanks again, from all of us at BISSELL.

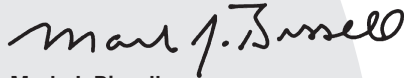

Mark J. Bissell

President and Chief Executive Officer

# IMPORTANT SAFETY INSTRUCTIONS

When using an electrical appliance, basic precautions should be observed, including the following:

## READ ALL INSTRUCTIONS BEFORE USING YOUR UPRIGHT VACUUM.

Always connect to a polarized outlet (left slot is wider than right). Unplug from outlet when not in use and before conducting maintenance.

### **WARNING:** To reduce the risk of fire, electric shock, or injury:

- Do not modify the polarized plug to fit a non-polarized outlet or extension cord.
- Do not leave vacuum cleaner unattended when it is plugged in.
- Unplug from outlet when not in use and before servicing.
- Unplug before attaching TurboBrush.
- Do not use outdoors or on wet surfaces.
- Do not allow children to operate vacuum cleaner or use as a toy.
- Close attention is necessary when used by or near children.
- Do not use for any purpose other than described in this User's Guide.
- Use only manufacturer's recommended attachments.
- Do not use with damaged cord or plug.
- If appliance is not working as it should, has been dropped, damaged, left outdoors, or dropped into water, have it repaired at an authorized service center.
- Do not pull or carry by cord, use cord as a handle, close a door on cord, or pull cord around sharp edges or corners. Do not run appliance over cord. Keep cord away from heated surfaces.
- Do not unplug by pulling on cord. To unplug, grasp the plug, not the cord.
- Do not handle vacuum cleaner or plug with wet hands.
- Do not put any object into openings. Do not use with any opening blocked; keep openings free of dust, lint, hair, and anything that may reduce air flow.
- Keep hair, loose clothing, fingers, and all parts of body away from openings and moving parts.
- Turn off all controls before plugging or unplugging vacuum cleaner.
- Use extra care when cleaning stairs.
- Do not pick up flammable materials (lighter fluid, gasoline, kerosene, etc.) or use in the presence of explosive liquids or vapors.
- Do not pick up toxic material (chlorine bleach, ammonia, drain cleaner, etc.).
- Do not use vacuum cleaner in an enclosed space filled with vapors given off by oil base paint, paint thinner, some moth proofing substances, flammable dust, or other explosive or toxic vapors.
- Do not pick up hard or sharp objects such as glass, nails, screws, coins, etc.
- Do not pick up anything that is burning or smoking, such as cigarettes, matches, or hot ashes.
- Do not use without filters in place.
- Use only on dry, indoor surfaces.
- Keep appliance on a level surface.
- Do not carry the vacuum cleaner while it is running.

**WARNING:** The Power Cord on this product contains lead, a chemical known to the State of California to cause birth defects or other reproductive harm. **WASH HANDS AFTER HANDLING.**

## SAVE THESE INSTRUCTIONS FOR FUTURE USE

## THIS APPLIANCE HAS A POLARIZED PLUG.

To reduce the risk of electric shock, this appliance has a polarized plug (one blade is wider than the other). This plug will fit in a polarized outlet only one way. If the plug does not fit fully in the outlet, reverse the plug. If it still does not fit, contact a qualified electrician to install a proper outlet. Do not change the plug in any way.

This model is for household use only.

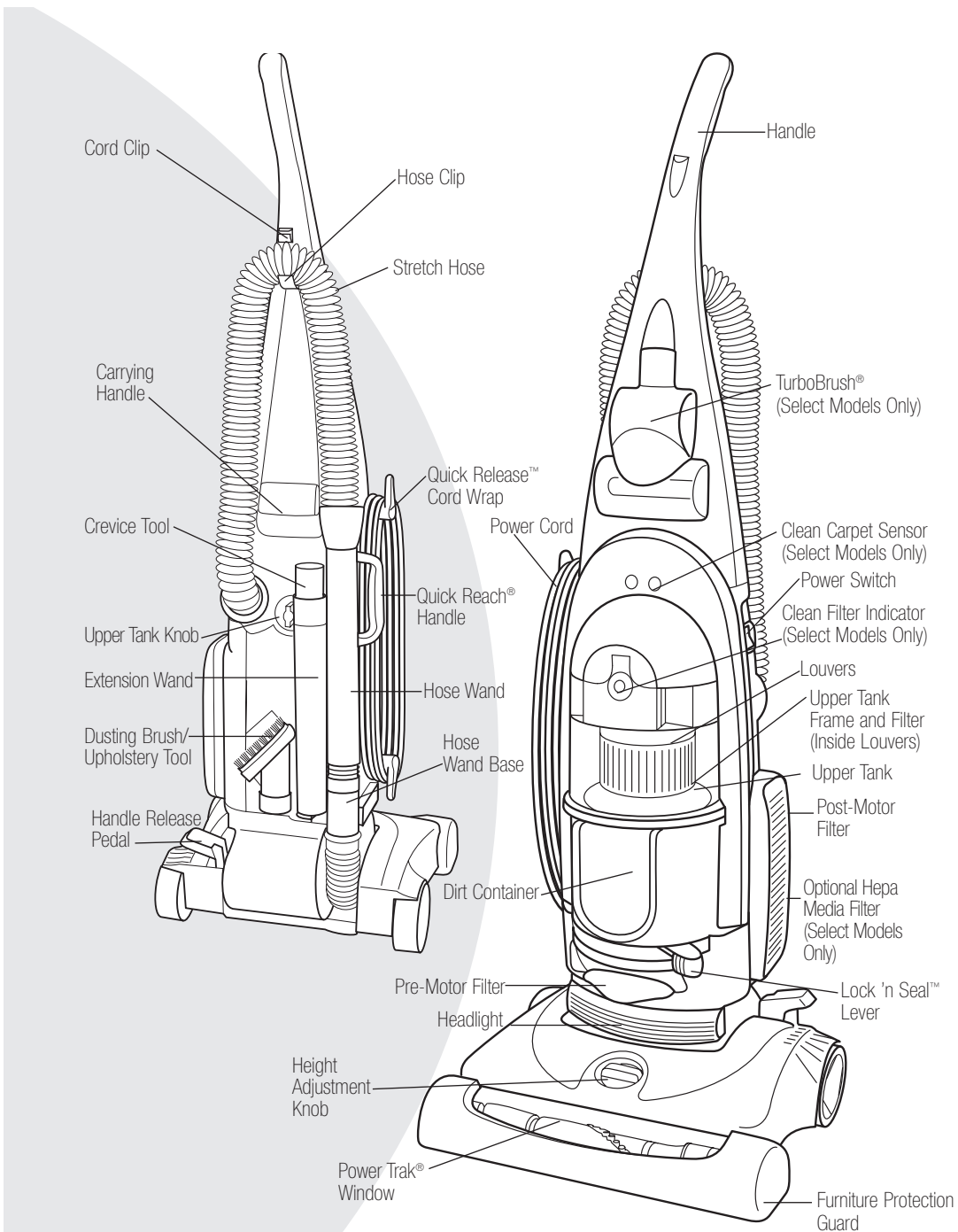

**⚠ CAUTION:**  
 Do not plug in your vacuum cleaner until you are familiar with all instructions and operating procedures.

## How To Use This Guide

This User's Guide has been designed to help you get the most satisfaction from your BISSELL CleanView. You'll find assembly and operating instructions, safety precautions, as well as maintenance and troubleshooting instructions. Please read this Guide thoroughly before assembling your vacuum cleaner.

Pay particular attention to the product diagram, assembly instructions, and part names. Locate and organize all parts before assembly. Familiarize yourself with the parts and where they fit. Following this User's Guide will greatly enhance your ability to get the most performance from your BISSELL CleanView for many years.



### **WARNING:**

**Plastic film can be dangerous. To avoid danger of suffocation, keep away from babies and children.**

## How To Put It Together

The only tool you'll need to assemble your vacuum cleaner is a screwdriver.

### Attach Handle To Vacuum

1. Locate the vacuum Handle and remove the screw packet taped to the base of the Handle.
2. Stand the vacuum upright and slide the base of the Handle firmly into the grooves at the top of the vacuum body.
3. Check to be sure the Handle is fitted to the vacuum body. If there is a gap in front, continue to push firmly until the Handle is flush.
4. Insert the screw provided from the screw packet into the existing hole. Tighten securely with a screwdriver.

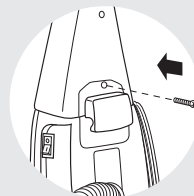
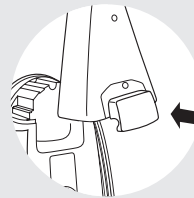

## Attach Vacuum Hose and Tools

1. Position the Hose Assembly on the back of the vacuum as shown.
  2. Attach the Hose with the remaining two screws from the packet. Tighten securely with a screwdriver.  
**For Models with the Twist 'n Snap™ Hose**
    - 1a Position the Twist 'n Snap Hose assembly on the back of the vacuum.
    - 2a Line up the tabs on the base of the Twist 'n Snap Hose with the corresponding notches on the hose collar as shown.
    - 3a Turn the Twist 'n Snap Hose to the right to lock the hose into place.
  3. Grasping the Quick Reach Handle, slide the end of the Hose Wand onto the Hose Wand Base. Snap the Hose into the Hose Clip.
- NOTE: The Powerfoot will not operate effectively unless the Hose Wand is firmly attached.**
4. Slide the Extension Wand and the Crevice Tool together into the storage clip as shown.
  5. Slide the Dusting Brush/Upholstery Tool into the storage clip as shown.
  6. Attach the TurboBrush by aligning the small holes near the brush roll with the tabs at the bottom of TurboBrush housing. Snap TurboBrush into place as shown.

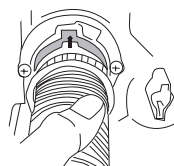
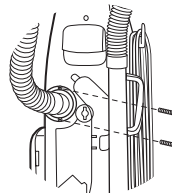

Twist 'n Snap Hose Models

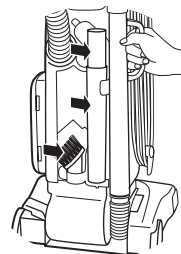

Select Models Only

### NOTICE:

The Floor Brush will continue to rotate while you use your vacuum for above floor cleaning. To prevent carpet damage, do not lean on the vacuum or let the Powerfoot tilt forward.



### CAUTION:

Before using your vacuum, make sure that the Dirt Container and Upper Tank are in locked position and that all filters (UpperTank, Pre-Motor and Post-Motor) are in place. Do not operate your vacuum without these filters.

## How To Use Your Vacuum

### Handle Positions

Press the Handle Release Pedal with your foot to place your vacuum into one of three cleaning positions.

1. Upright- For storage and above floor cleaning with tools.
2. Normal Cleaning- Press Handle Release Pedal once. Use for most household floor cleaning tasks.
3. Low Cleaning- With the vacuum in normal cleaning position, press Handle Release Pedal again. Use for reaching under low furniture such as tables, chairs or beds.

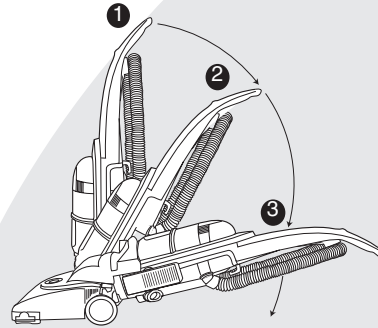

### Height Adjustment

The Powerfoot/Rotating Floor Brush on your vacuum can be adjusted to clean several floor surfaces.

**NOTE: For optimal cleaning performance, adjust to the lowest practical setting. If your cleaner is difficult to push, adjust to the next higher setting.**

1. Place Handle in Upright Position.
2. Turn Height Adjustment knob to desired setting.
  - Lowest Setting** For bare floors.
  - Medium Settings** For short and medium pile carpets.
  - Highest Setting** For plush pile carpet.
3. Place the Handle in the normal cleaning position and the Powerfoot will adjust to the setting chosen.

**NOTE: You may also adjust the setting while in the normal cleaning position.**

#### Tip:

Before cleaning under low furniture, check area first for objects that might harm the unit or block the Vacuum Hose.

#### Tip:

Your vacuum features a Quick-Release Cord Wrap. To remove the Power Cord quickly and easily, rotate the Upper Cord Wrap towards floor, and slip Power Cord from Upper and Lower Cord Wraps.

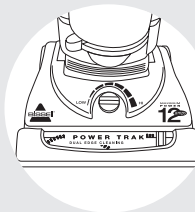

### Transporting Cleaner

1. To move your cleaner from room to room, put the Handle in the upright position, tilt the cleaner back on its rear wheels and push forward.
2. The cleaner can also be moved by using the Carrying Handle.

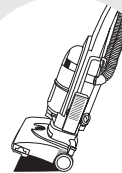

## Clean Carpet Sensor

### Select models only

The Clean Carpet Sensor detects dirt being picked up while the vacuum is in use. When the vacuum is picking up dirt, the red light will come on. Occasionally, the lights may alternate quickly back and forth if the area is only lightly soiled or the dirt is spread out. For the best cleaning, continue to vacuum until the green light remains constantly illuminated.

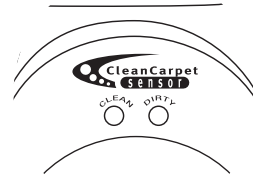

## Clean Filter Indicator

### Select Models Only

The Clean Filter Indicator tells you when airflow in the vacuum is reduced due to dirty filters or a clog in the hose. The Clean Filter Indicator will remain green until the airflow is reduced. At that time, it begins to change to red. When it is fully red, the airflow is significantly reduced or blocked. Follow the steps on page 11 to clean your filters. All filters in the vacuum should be cleaned or replaced when the Clean Filter Indicator turns red.

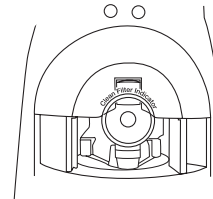

If the indicator remains red after all filters have been cleaned, follow the steps on pages 12-13 to check for and clear clogs.

### **NOTICE:**

While vacuuming, certain carpets and low humidity conditions may generate small static discharges. The discharges are entirely harmless and are not associated in any way with the main power supply.



## Special On-Board Tools

Your vacuum is not only a powerful carpet and rug vacuum cleaner, it's also a versatile above floor vacuum cleaner when you select one of the special tools.

1. Raise Handle to Upright Position.
2. Grasp the Quick Reach Handle and lift Hose Wand to separate from suction intake opening.
3. Attach tools by firmly pushing onto Vacuum Hose or Extension Wand.

**Dusting Brush Tool (Select Models):** Use to dust furniture, blinds, books, lamps, shelves, draperies, and cushions.

**Dusting Brush/Upholstery Tool (Select Models):** Two types of cleaning tools in one attachment.

- Use the Dusting Brush to dust furniture, blinds, books, lamps, shelves and baseboards.
- Slide the brush off to use the Upholstery Tool on cushions, draperies and fabrics.

**Crevice Tool:** Use in tight narrow spaces.

**Extension Wand:** Use with desired attachment for a longer reach.

**TurboBrush (Select Models):** Use rotating brush action for small areas such as stairs and upholstery.

**Note:** Press gently when using the TurboBrush to gain maximum cleaning. Too much pressure will cause the brush to stop rotating.

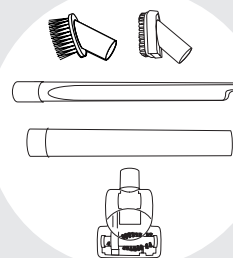
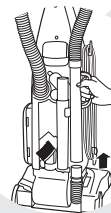

### Tip:

Hair, string and small objects can block the Vacuum Hose or Tools. Check them occasionally for obstructions.

### NOTICE:

The Floor Brush will continue to rotate while you use your vacuum for above floor cleaning. To prevent carpet damage, do not lean on the vacuum or let the Powerfoot tilt forward.

## Power Cord Storage

When you are done using your vacuum, return it to the Upright position and store the Power Cord.

1. Turn vacuum cleaner off.
2. Unplug Power Cord by grasping the polarized plug (NOT the cord) and disconnect from outlet.
3. Loop Power Cord around Cord Wraps on side of vacuum cleaner.
4. Clip molded plug to Power Cord to secure.



### CAUTION:

The Rotating Floor Brush continues to rotate while tools are in use. To reduce the risk of injury from moving parts, always move the cleaner with the Carrying Handle at the back of the cleaner. Always place vacuum cleaner on floor with Handle in Upright position when using tools. Never place your fingers under the cleaner when it is running. Never place Powerfoot on furniture or uneven surfaces. Do not place vacuum cleaner close enough to objects to pull them into rotating brush.

## How To Maintain Your Vacuum

To maximize your **cleaning performance** and **extend the life** of your vacuum, it is very important that you empty your dirt container and check and clean your filters frequently. Perform the following maintenance steps:

1. Empty the Dirt Container when the dirt reaches the "Full" line on the side.
2. Check the Upper Tank and Pre-Motor Filters at least once a month and clean or replace as needed.
3. Clean or replace the Post-Motor Filter every three to six months.

**Note: More frequent filter cleaning may be necessary if you are vacuuming new carpet, fine dust, or have allergy concerns. Follow the instructions on the following pages to perform these simple maintenance steps.**

### Empty Dirt Container

The Dirt Container needs to be emptied when the dirt reaches the "Full" line on the side of the Container.

1. Unplug cleaner from electrical outlet.
2. Slide the Lock 'n Seal Lever to the "Unlock" position.
3. Grasp handle and pull the Dirt Container straight out to remove from vacuum.
4. Empty dirt into garbage container.
5. Put the Dirt Container back in the vacuum and slide the lever to the "Lock" position.

**Note: The Dirt Container may be washed in warm water with a mild detergent. Make sure it is completely dry before using again.**

### Clean Carpet Sensor

To maintain the effectiveness of the Clean Carpet Sensor, a quarterly cleaning of the internal sensor lens is recommended. To clean the sensor lens, detach the Twist 'n Snap Hose and **gently** wipe the clear lens area using a lightly dampened **soft** cloth. Allow enough time for the lens to dry thoroughly before reattaching the Twist 'n Snap Hose and using the vacuum.



### WARNING:

To reduce the risk of electric shock, turn Power Switch OFF and disconnect polarized plug from electrical outlet before performing maintenance or troubleshooting checks.

### Tip:

For maximum cleaning performance, check and clean or replace all filters as suggested.

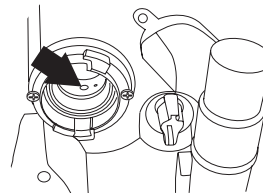
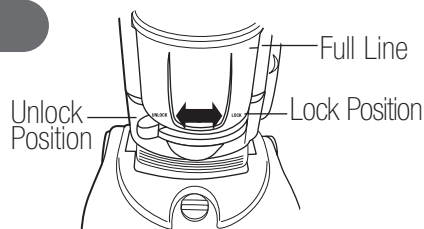

## Cleaning The Upper Tank & Filter

1. Unplug the cleaner from electrical outlet.
2. The Upper Tank Filter can be reached by removing the Dirt Container, reaching underneath the Upper Tank and turning the rim of the Filter Frame to unlock. Pull straight down to remove. Brush the dirt off the Louvers and Upper Tank Filter.
3. The foam Upper Tank Filter may be removed and hand washed in cold water with mild detergent. Rinse well then air dry thoroughly before replacing.
4. The Upper Tank and Louvers may also be wiped clean with a damp cloth.

**Note: For easier access, the entire Upper Tank may be removed by turning the knob on the back of the cleaner to unlock and pulling the entire tank straight out.**

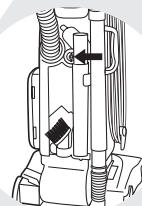
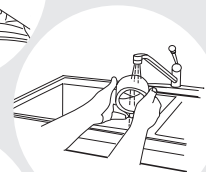
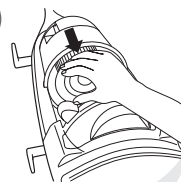

## Cleaning The Pre-Motor and Post-Motor Filter

1. Unplug the cleaner from electrical outlet.
2. The Pre-Motor Filter protects the motor from dirt particles. It is located in the slide out tray underneath the Dirt Container. If the filter becomes dirty, pull out the tray, lift out the filter and clean.
3. The Post-Motor Filter assists in the filtration process to return clean air to the room. It is located behind the door on the side of the cleaner. If the filter becomes dirty, open the door, remove the filter and clean.

**Note: Select Models come with a white, pleated HEPA Media Filter. This filter is not washable and must be replaced.**

4. The standard filters may be hand washed in cold water with mild detergent. Rinse well and air dry thoroughly before replacing.



**WARNING:**  
Do Not operate cleaner with damp or wet filters or without all filters in place.

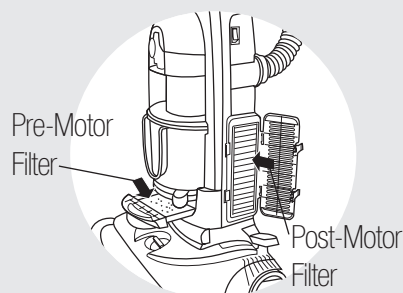

## Check Rotating Floor Brush and Drive Belt

You should check your vacuum cleaner's Rotating Floor Brush and Drive Belt regularly for wear or damage. You should also clean the brush and brush ends of strings, hair, and carpet fibers. These can wrap around the brush and hamper its ability to effectively clean your carpet. Also remove any debris that has accumulated under the brush cover.

1. Unplug cleaner from electrical outlet.
2. Place handle in Low position and turn vacuum cleaner over so bottom side is up.
3. Remove the five screws as shown with a Phillips head screwdriver. Lift the Brush Cover off.



**WARNING:**  
To reduce the risk of injury from moving parts, turn off vacuum cleaner and disconnect Power Plug from electrical outlet.

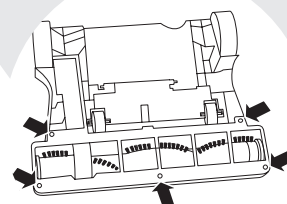

## Check Rotating Floor Brush and Drive Belt Continued

4. Grasp Rotating Floor Brush at both ends and lift.
5. Clean strings, hair and other debris from Rotating Floor Brush, paying particular attention to brush ends.
6. Clean strings, hair and other debris from Motor Pulley and Drive Belt areas.
7. Check Drive Belt carefully for wear, cuts or stressed areas.
8. Check Air Passageway for obstructions. Remove debris from this area.

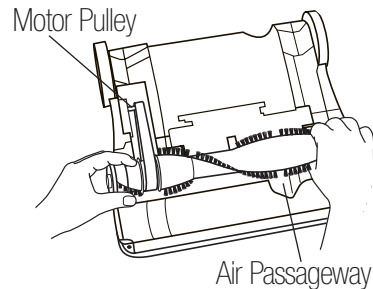

## Replace Drive Belt

1. Unplug cleaner from electrical outlet.
2. With Rotating Floor Brush removed from vacuum cleaner (Steps 1-4 of check Rotating Floor Brush and Drive Belt), grasp old Drive Belt and remove from Motor Pulley. Discard old Drive Belt.
3. Place new Drive Belt over Motor Pulley and stretch other end over Rotating Floor Brush in the space between the bristles.
4. Place ends of Rotating Floor Brush down into slots on sides as shown.
5. Turn Rotating Floor Brush by hand several times in the direction of Motor Pulley. If properly installed, Drive Belt will center itself on Rotating Brush crown.
6. Reposition Brush Cover and screws. Tighten screws securely.

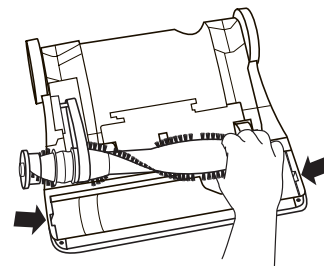

## Replace Lightbulb

1. Unplug cleaner from electrical outlet
2. Using a screwdriver, remove the two screws as shown and lift off the lens.
3. Remove the bulb from the socket by pushing in gently and turning it counterclockwise. Install the new bulb by pushing it gently into the socket and turning clockwise.
4. Reposition lens and secure with the two screws.

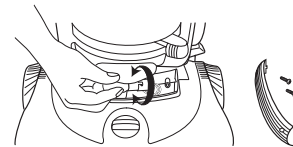
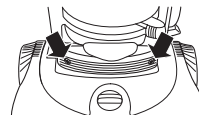

## Maintaining Optional TurboBrush

### Select Models Only

If a clog is present, unscrew the two screws in the back of the TurboBrush to remove the faceplate and clear any obstructions.

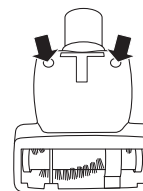

## Clearing Clogs

Low suction or poor pickup may be due to a clog in the vacuum cleaner. If you notice a change in the sound of the motor or a reduction in the spinning action, check for clogs.

1. Unplug cleaner from electrical outlet.
2. Empty Dirt Container.
3. Check Upper Tank for build up or clogs.
4. Remove the Upper Tank and check the suction inlet for a clog.
5. Grasp the Quick Reach Handle and lift Hose Wand to separate from the suction opening. Check for a clog in the Base, the Wand or the Hose.

### For Models with the Twist 'n Snap Hose

Release the hose from the vacuum by turning to the left. Straighten the hose and unclog with a long, narrow object.

6. Remove the screw attaching the Hose Wand Base to the vacuum. Straighten the Hose Wand Base and unclog with long, narrow object.
7. If the clog persists, follow the instructions for Checking the Rotating Floor Brush on page 12 and inspect the Air Passageway for obstructions.

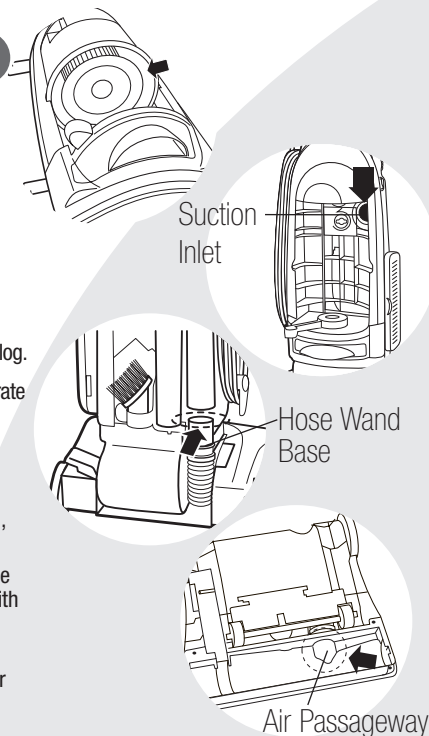

## BISSELL Consumer Services

For information about repairs or replacement parts, or questions about your warranty, call:

**BISSELL Consumer Services**  
**1-800-237-7691**

Monday - Friday      8 a.m. — 10 p.m. ET  
Saturday              9 a.m. — 8 p.m. ET

Or write:

BISSELL Homecare, Inc.  
PO Box 3606  
Grand Rapids, MI 49501  
ATTN: Consumer Services

Or visit the BISSELL website - [www.bissell.com](http://www.bissell.com)

When contacting BISSELL, have model number of unit available.

Please record your Model Number: \_\_\_\_\_

Please record your Purchase Date: \_\_\_\_\_

**NOTE: Please keep your original sales receipt. It is your warranty.**

## Troubleshooting

### Vacuum cleaner won't run

#### Possible Causes

- 1 Power cord not plugged in
- 2 Blown fuse/tripped breaker

### Vacuum cleaner or Tools won't pick up dirt

#### Possible Causes

- 1 Incorrect Height Adjustment
- 2 Hose not attached to suction opening
- 3 Twist 'n Snap Hose not securely attached
- 4 Crack or hole in Hose
- 5 Broken or worn Drive Belt
- 6 Rotating Floor Brush bristles worn
- 7 Rotating Floor Brush jammed
- 8 Clog in vacuum
- 9 Dirt Container full
- 10 Dirt Container or Upper Tank not installed properly
- 11 Filters are dirty

### Vacuum cleaner is difficult to push

#### Possible Causes

- 1 Incorrect Height Adjustment

### Visible dirt escaping from cleaner

#### Possible Causes

- 1 Dirt Container full
- 2 Filters missing or installed incorrectly
- 3 Dirt Container installed incorrectly

### Clean Carpet Sensor not functioning properly

#### Possible Causes

- 1 Clean Carpet Sensor Lens is Dirty
- 2 Clog in Suction Intake Area



## WARNING:

To reduce the risk of injury from moving parts and/ or electrical shock, turn Power Switch OFF and disconnect polarized plug from electrical outlet before performing troubleshooting checks.

#### Remedies

- 1 Check electrical plug
- 2 Check/Replace fuse or reset breaker

#### Remedies

- 1 Adjust Powerfoot to correct height
- 2 Firmly push Hose Wand into the suction opening
- 3 Make sure Twist 'n Snap Hose is snapped into locked position
- 4 Check Hose and replace if needed
- 5 Replace Drive Belt, see page 12
- 6 Replace brush
- 7 Remove brush and clean debris from brush ends
- 8 Clear clog, see pages 12-13
- 9 Empty Dirt Container
- 10 Position correctly and lock in place
- 11 Check and clean Upper Tank, Pre-Motor and Post-Motor Filters

#### Remedies

- 1 Adjust Powerfoot to correct height setting

#### Remedies

- 1 Empty Dirt Container
- 2 Check Upper Tank, Pre-Motor and Post-Motor Filters for correct installation
- 3 Pull out and re-insert Dirt Container correctly

#### Remedies

- 1 Clean Internal Sensor Lens, see page 10
- 2 Clear clog, see pages 12-13

## Replacement Parts – BISSELL Power Trak Series

You may purchase replacement parts from your retailer, by calling BISSELL Consumer Services or by visiting our website. To locate a retailer near you, or to place an order using Visa, MasterCard, Discover or American Express, call

**BISSELL Consumer Services**

**1-800-237-7691**

Or visit our Website - [www.bissell.com](http://www.bissell.com)

Item	Part No.	Part Name
1	32074	Style 7/9/10 Drive Belt (2-Pack)
2	203-1007	Headlight Bulb
3	203-1063	Crevice Tool
4	203-1083	Dusting Brush
5	203-1228	Dusting Brush/Upholstery Tool (Select Models Only)
6	203-1227	TurboBrush (Select Models Only)
7	203-1084	Extension Wand
8	203-1164	Vacuum Hose
9	203-1036	Wire Reinforced Vacuum Hose Gray
10	203-2012	Wire Reinforced Vacuum Hose Clear
11	203-1055	Wire Reinforced Twist 'n Snap Vacuum Hose Gray
12	203-2035	Wire Reinforced Twist 'n Snap Vacuum Hose Clear
13	203-1128	Hose Collar with Screws (Twist 'n Snap Hose Only)
14	203-2013	Power Trak Brush Roll
15	3093	Style 7/8 Upper Tank Filter and Pre-Motor Filter Set
16	3099	Style 7 Post-Motor Filter Set (2 pack)
17	32076	Style 7 HEPA Media Post-Motor Filter (Select Models Only)

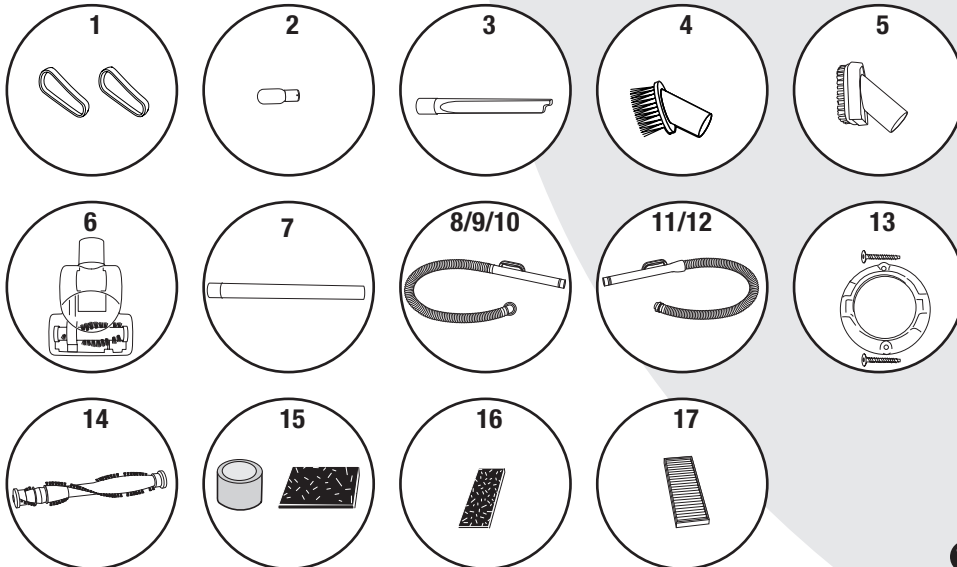



## Warranty

This warranty gives you specific legal rights, and you may also have other rights which may vary from state to state. If you need additional instruction regarding this warranty or have questions regarding what it may cover, please contact BISSELL Consumer Services by E-mail, telephone, or regular mail as described below.

### Limited One Year Warranty

Subject to the \*EXCEPTIONS AND EXCLUSIONS identified below, upon receipt of the product BISSELL Homecare, Inc. will repair or replace (with new or remanufactured components or products), at BISSELL's option, free of charge from the date of purchase by the original purchaser, for one year any defective or malfunctioning part.

See information below on "If your BISSELL product should require service".

This warranty applies to product used for personal, and not commercial or rental service. This warranty does not apply to fans or routine maintenance components such as filters, belts, or brushes. Damage or malfunction caused by negligence, abuse, neglect, unauthorized repair, or any other use not in accordance with the User's Guide is not covered.

#### If your BISSELL product should require service:

Contact BISSELL Consumer Services to locate a BISSELL Authorized Service Center in your area.

If you need information about repairs or replacement parts, or if you have questions about your warranty, contact BISSELL Consumer Services.

#### Website or E-mail:

[www.bissell.com](http://www.bissell.com)

Use the "Customer Services" tab.

#### Or Call:

BISSELL Consumer Services

1-800-237-7691

Monday - Friday 8 a.m. - 10 p.m. ET

Saturday 9 a.m. - 8 p.m. ET

#### Or write:

BISSELL Homecare, Inc.

PO Box 3606

Grand Rapids MI 49501

ATTN: Consumer Services

**BISSELL HOMECARE, INC. IS NOT LIABLE FOR INCIDENTAL OR CONSEQUENTIAL DAMAGES OF ANY NATURE ASSOCIATED WITH THE USE OF THIS PRODUCT. BISSELL'S LIABILITY WILL NOT EXCEED THE PURCHASE PRICE OF THE PRODUCT.**

Some states do not allow the exclusion or limitation of incidental or consequential damages, so the above limitation or exclusion may not apply to you.

#### \*EXCEPTIONS AND EXCLUSIONS FROM THE TERMS OF THE LIMITED WARRANTY

**THIS WARRANTY IS EXCLUSIVE AND IN LIEU OF ANY OTHER WARRANTIES EITHER ORAL OR WRITTEN. ANY IMPLIED WARRANTIES WHICH MAY ARISE BY OPERATION OF LAW, INCLUDING THE IMPLIED WARRANTIES OF MERCHANTABILITY AND FITNESS FOR A PARTICULAR PURPOSE, ARE LIMITED TO THE ONE YEAR DURATION FROM THE DATE OF PURCHASE AS DESCRIBED ABOVE.**

Some states do not allow limitations on how long an implied warranty lasts, so the above limitation may not apply to you.



©2004 BISSELL Homecare, Inc.  
Grand Rapids, Michigan  
All rights reserved. Printed in Korea  
Part Number 603-2564  
Rev 02/04  
Visit our website at:  
[www.bissell.com](http://www.bissell.com)